

Ravenna17-2U

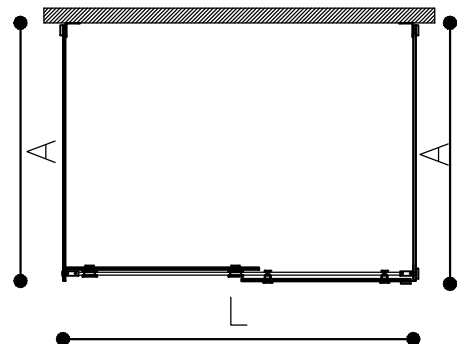

Installation manual

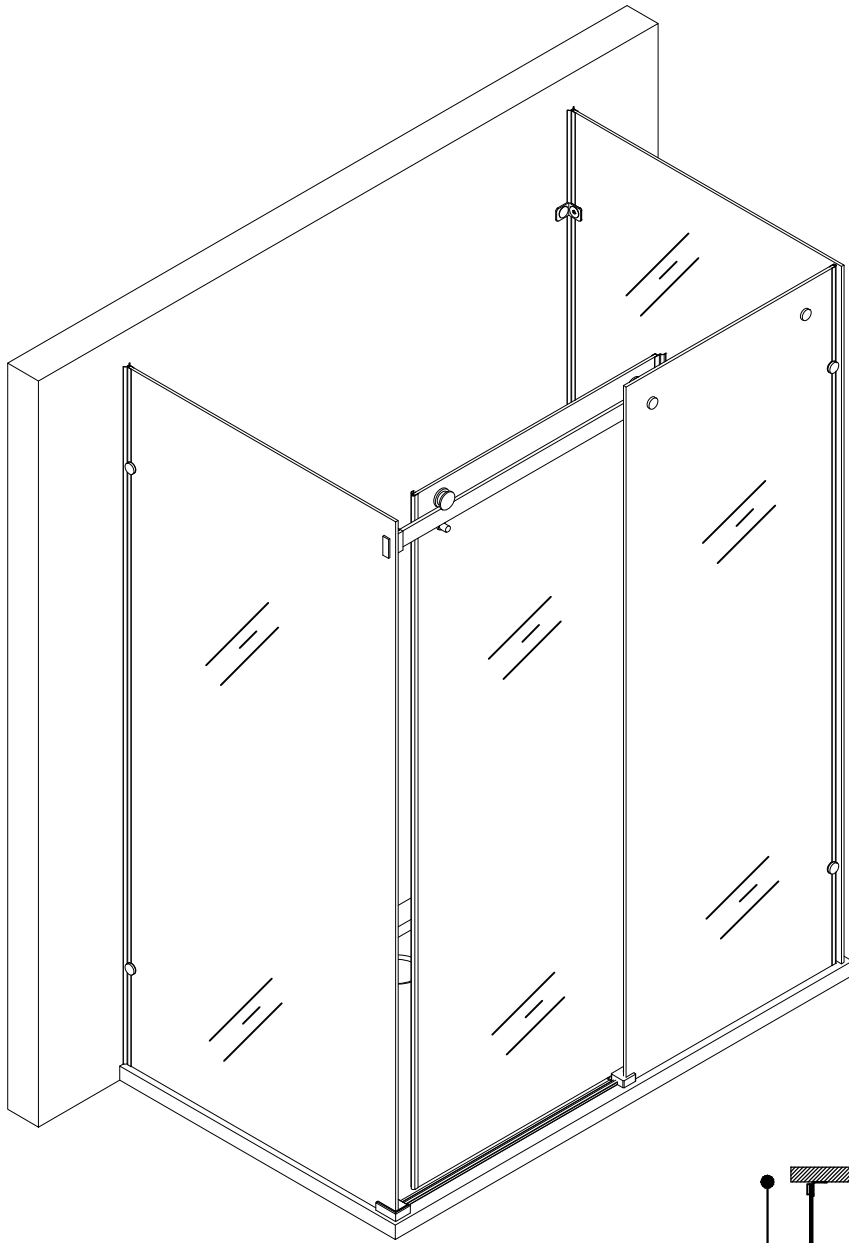
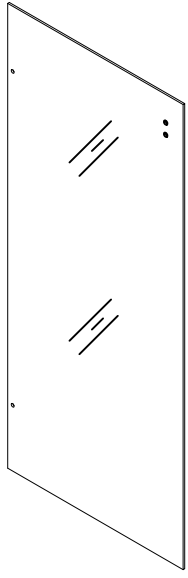

Side fixed glass-1

X1

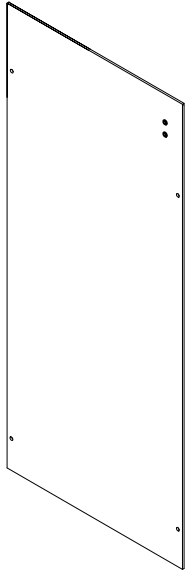

Side fixed glass-2

X1

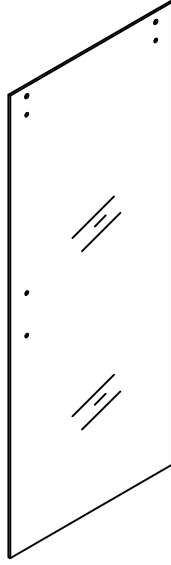

Door glass

X1

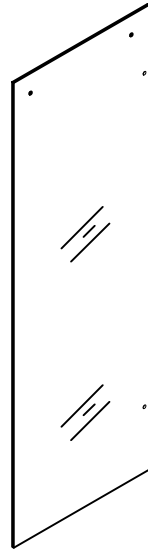

fixed panel

X1



1018拉手

X1



10*45方墙套

X2



φ48大铜轮

X2



防跳钉

X2



方管固定件

X2



光锁片

X2



C015A单圆角码

X4



C015A双圆角码

X2

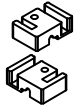

H003固定玻璃
导向块1/2

X2



F560侧固定转
角件1/2

X2

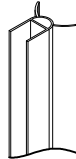

307AB

X2

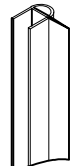

304AAK

X1



8MM-半圆防
水条

X1



S06

X1



D003

X1

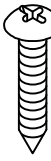

ST5*40

X6



φ8*40

X6



D017

X1



ST4*40

X4



φ6*40

X4

Tools for installation



(A)



(B)



(C)

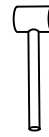

(D)

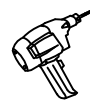

(E)



(F)

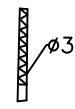

(G)

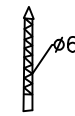

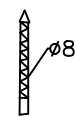

(H)





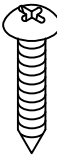
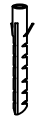

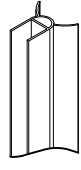

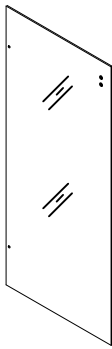
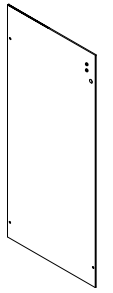
(I)

1

-  ST5*40 X4
-  $\phi 8*40$ X4
-  C015A单圆角码 X4
-  307AB X2

-  Side fixed glass-1 X1
-  Side fixed glass-2 X1

Tools for installation

-  (A)
-  (B)
-  (C)
-  (D)
-  (E)
-  (L)

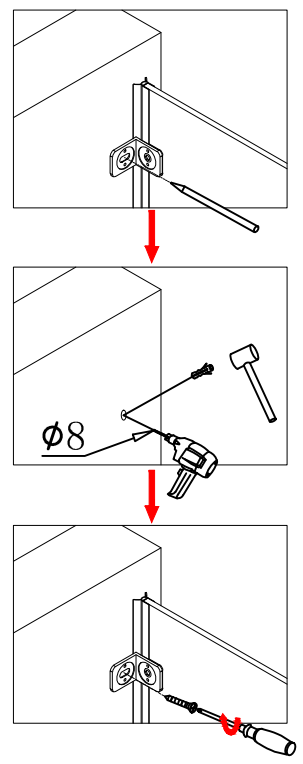
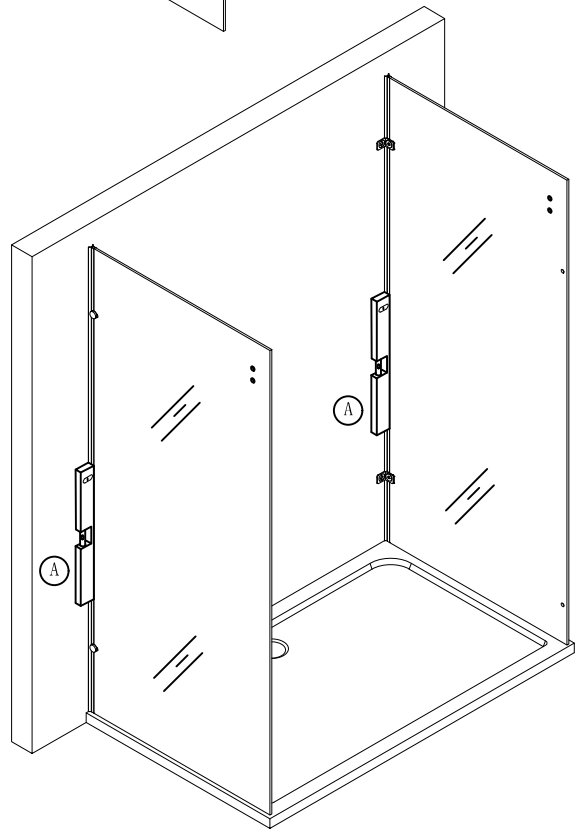
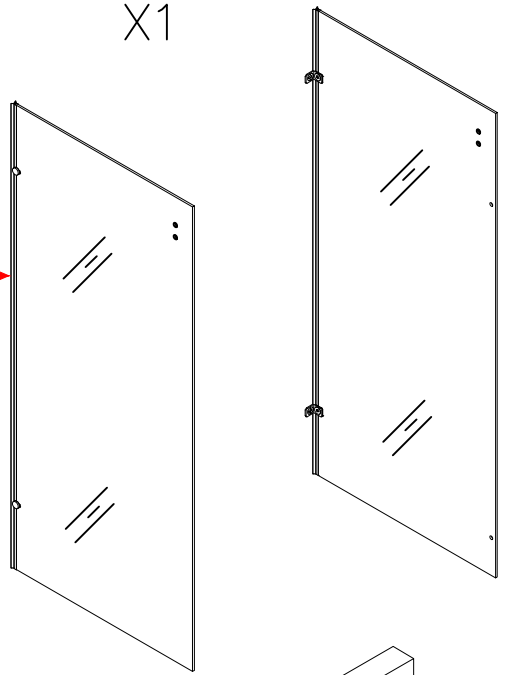
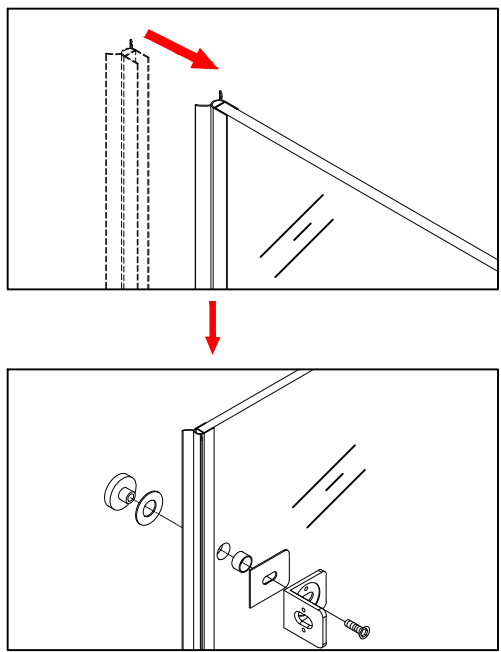

2

2

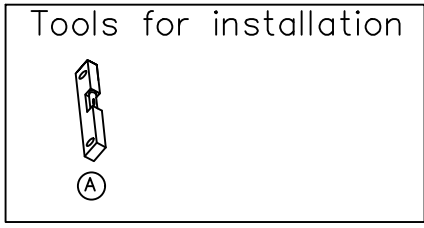

- 方管固定件
X2
- 光锁片
X2
- 10*45方墙套
X2
- D003
X1
- C015A双圆角码
X2
- 8MM—半圆防水条
X1

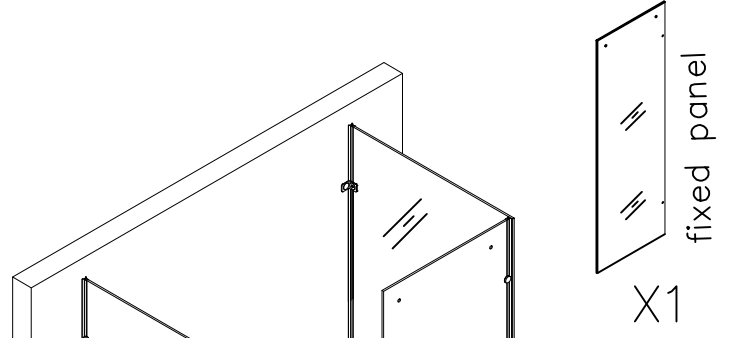
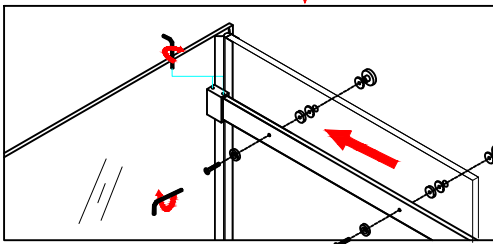
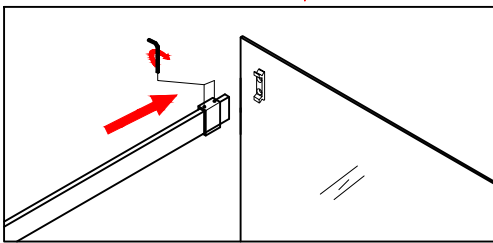
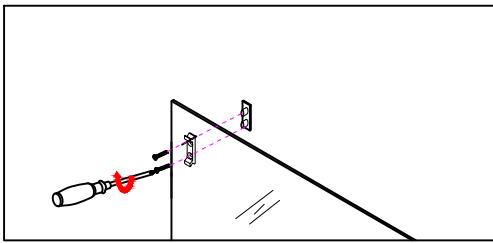
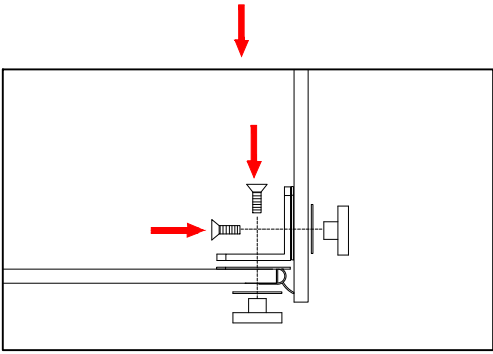
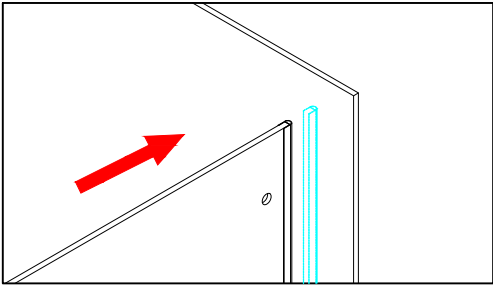

③

3

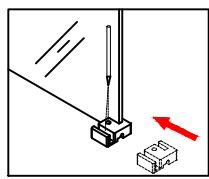
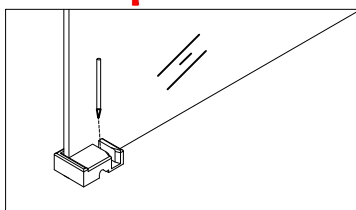
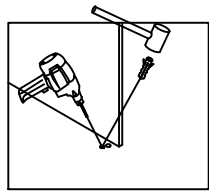
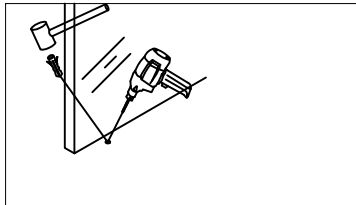
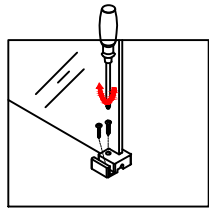
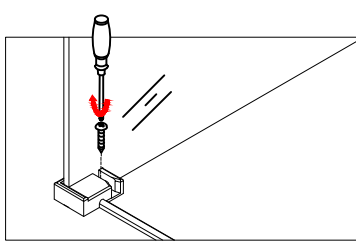
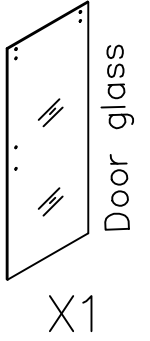
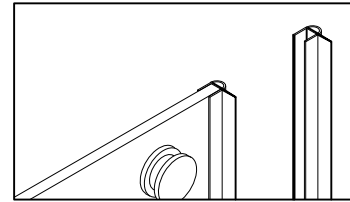
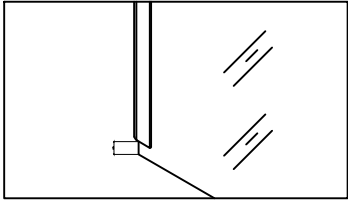
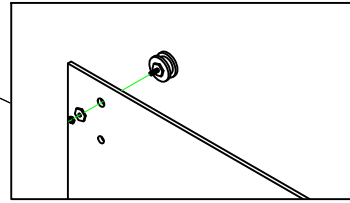
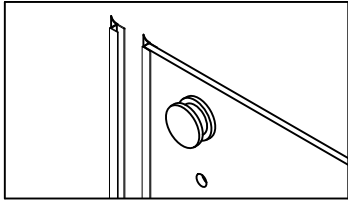
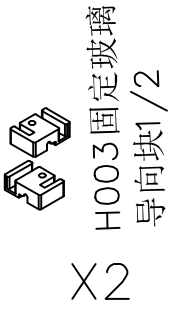
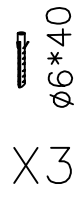
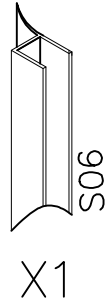
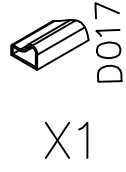
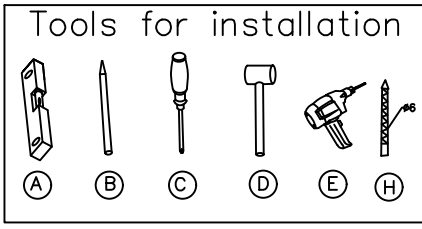

④

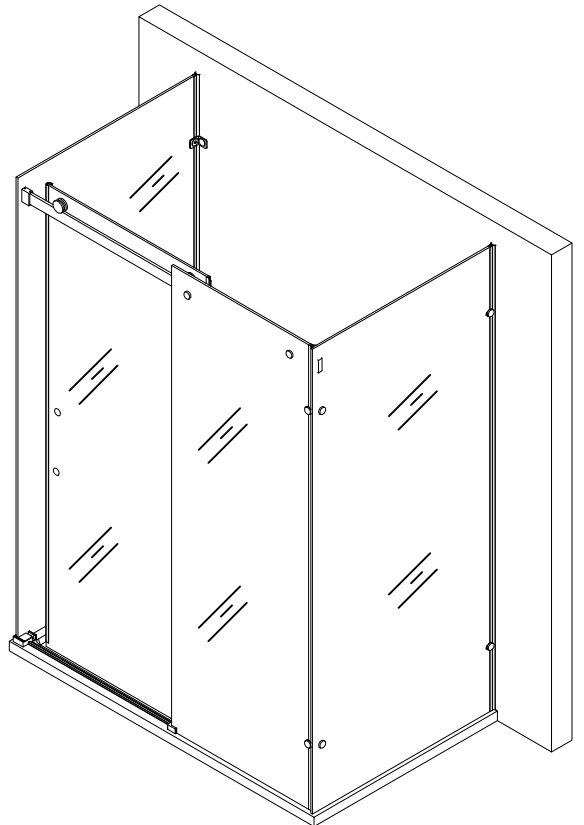

4

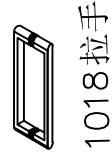

1018拉手

X1



防跳钉

X2

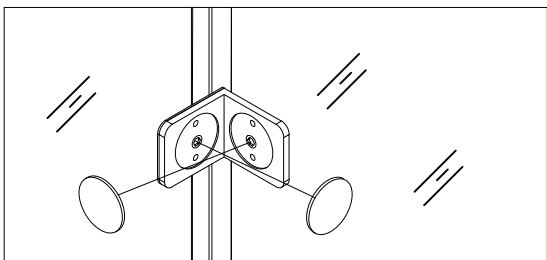
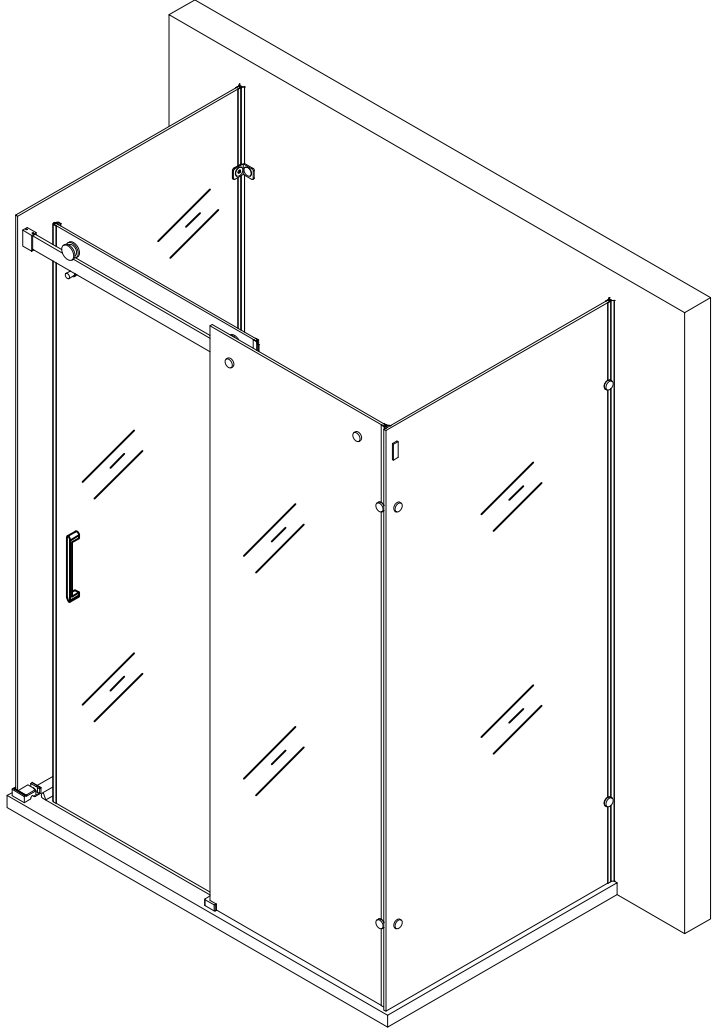
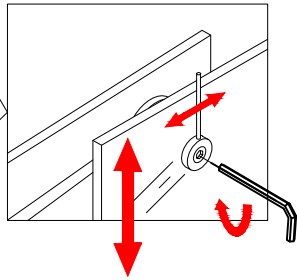
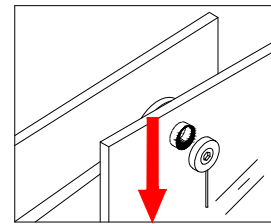
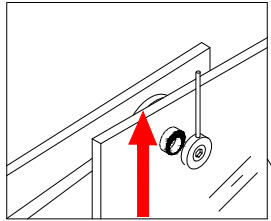
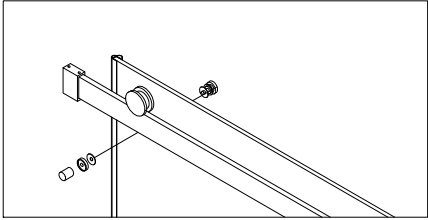
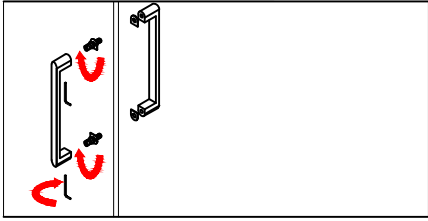

5

5

Tools for installation



Ⓜ

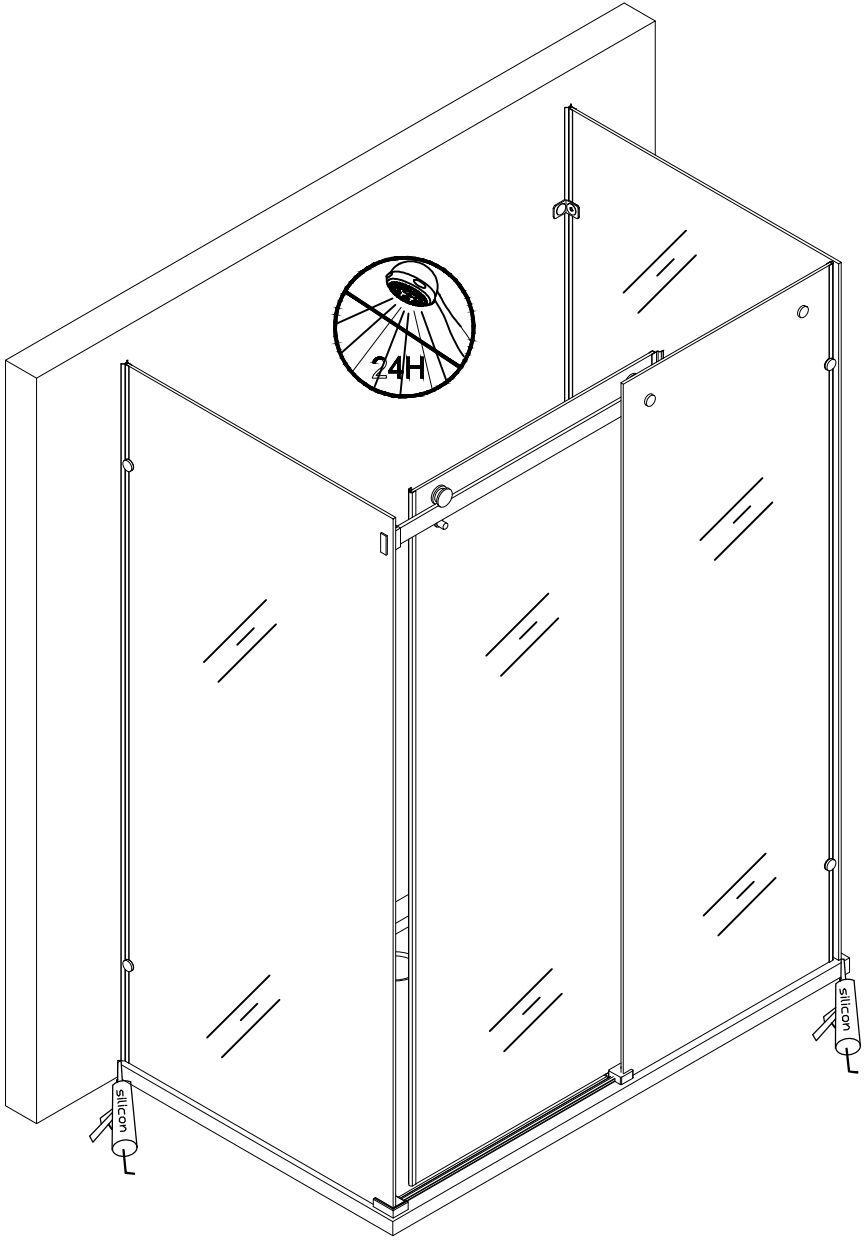

6